

W. C. & P. T. DODGE.
 Breech Loading Fire Arm.

No. 112,694.

Patented March 14, 1871.

Fig. 1.

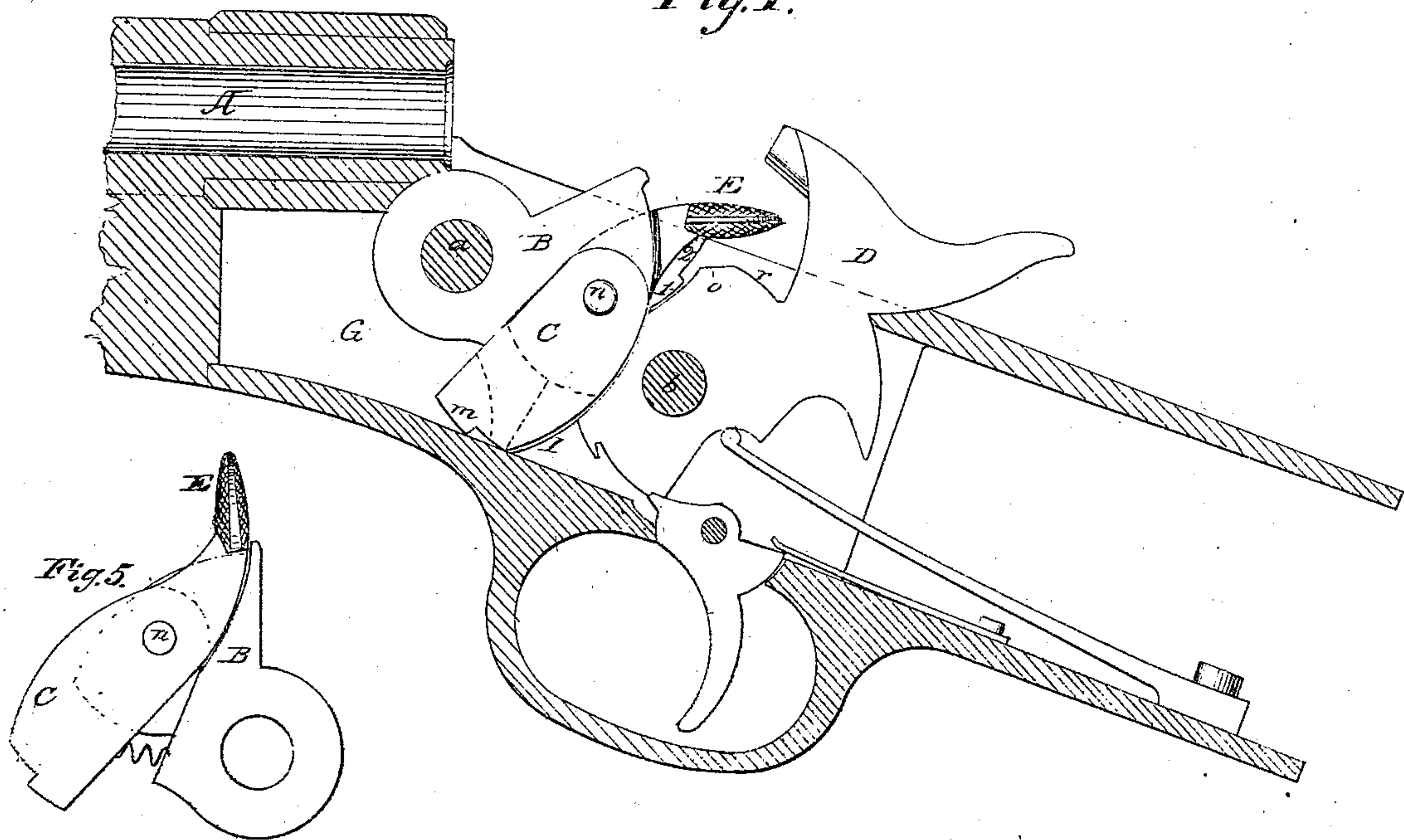
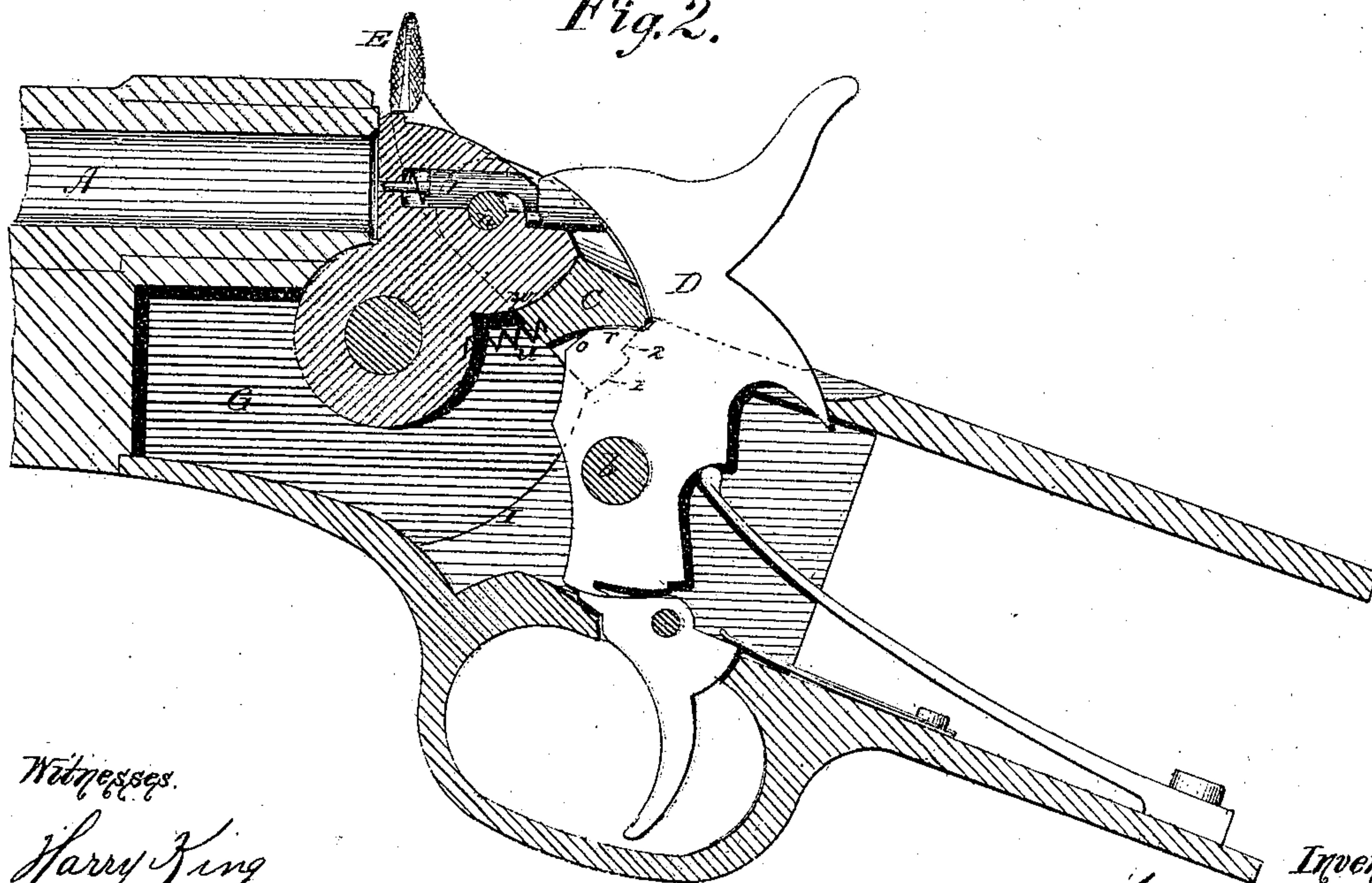

Fig. 2.



Witnesses.

*Harry King
 W. C. Anderson*

Inventors.

*Wm. C. Dodge
 Philip T. Dodge*

W. C. & P. T. DODGE.
BREECH LOADING FIRE ARM.

No. 112,694.

Patented Mar. 14, 1871.

Fig 3

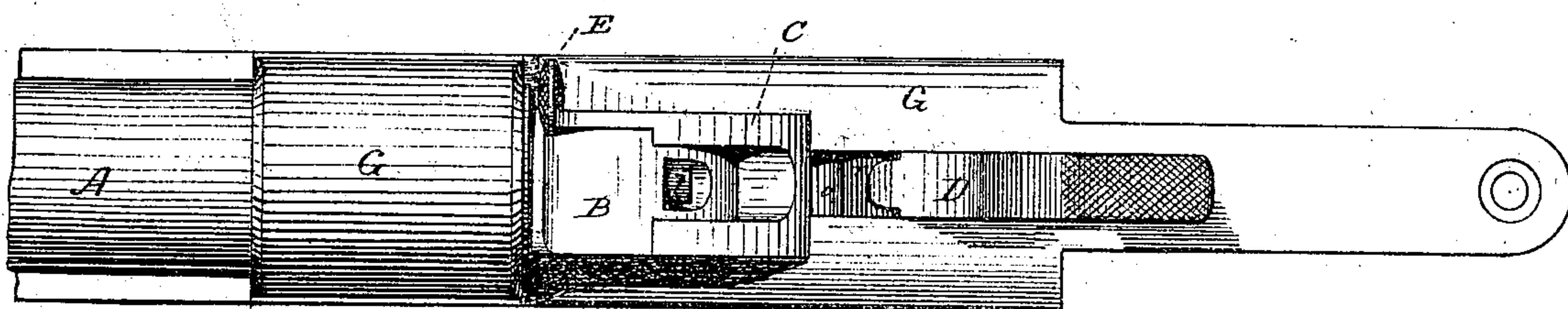

Fig. 6.

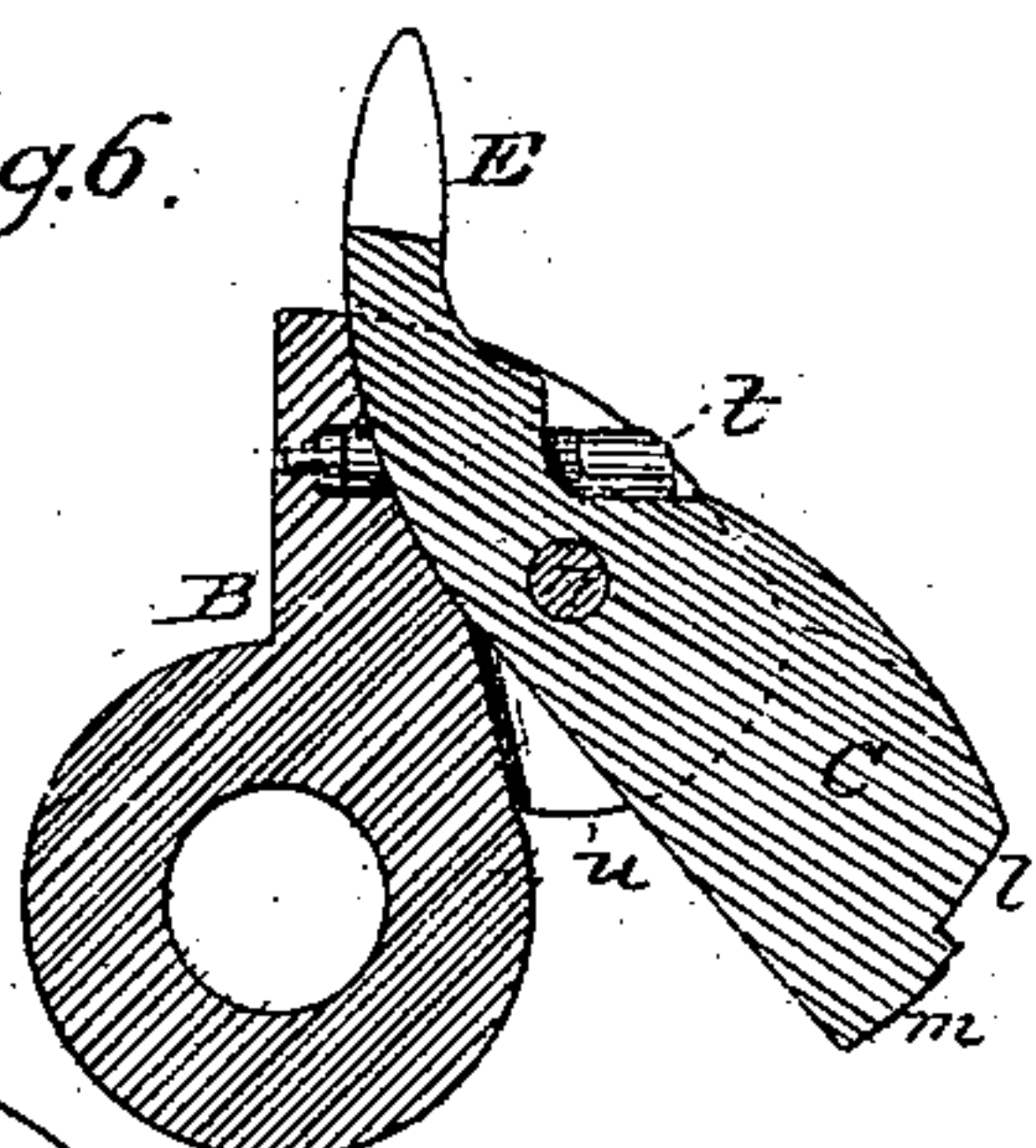

Fig. 7.

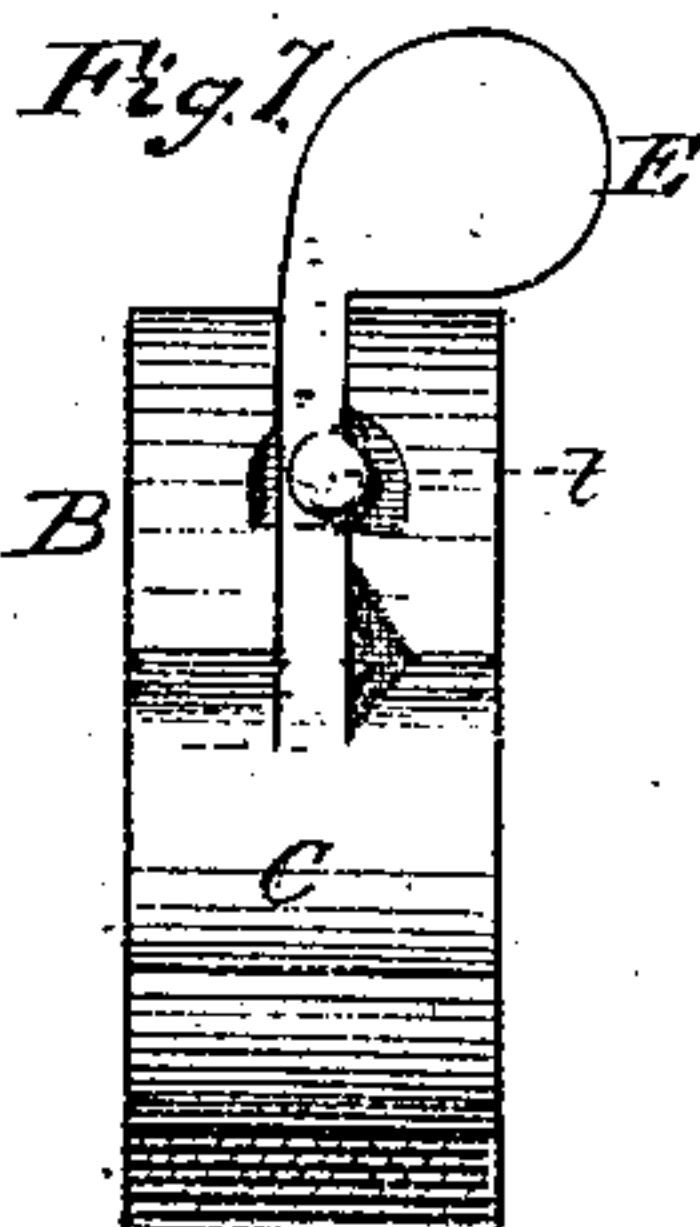

Fig. 8.

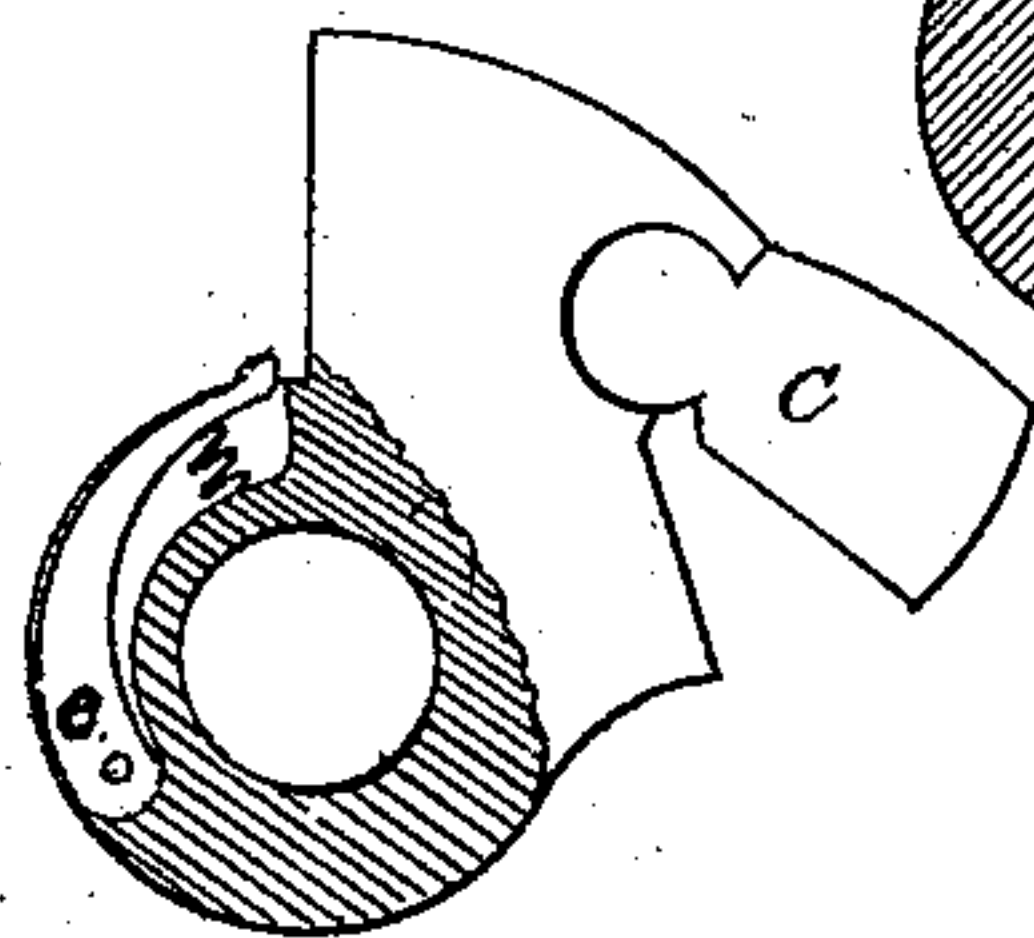

Fig. 10.

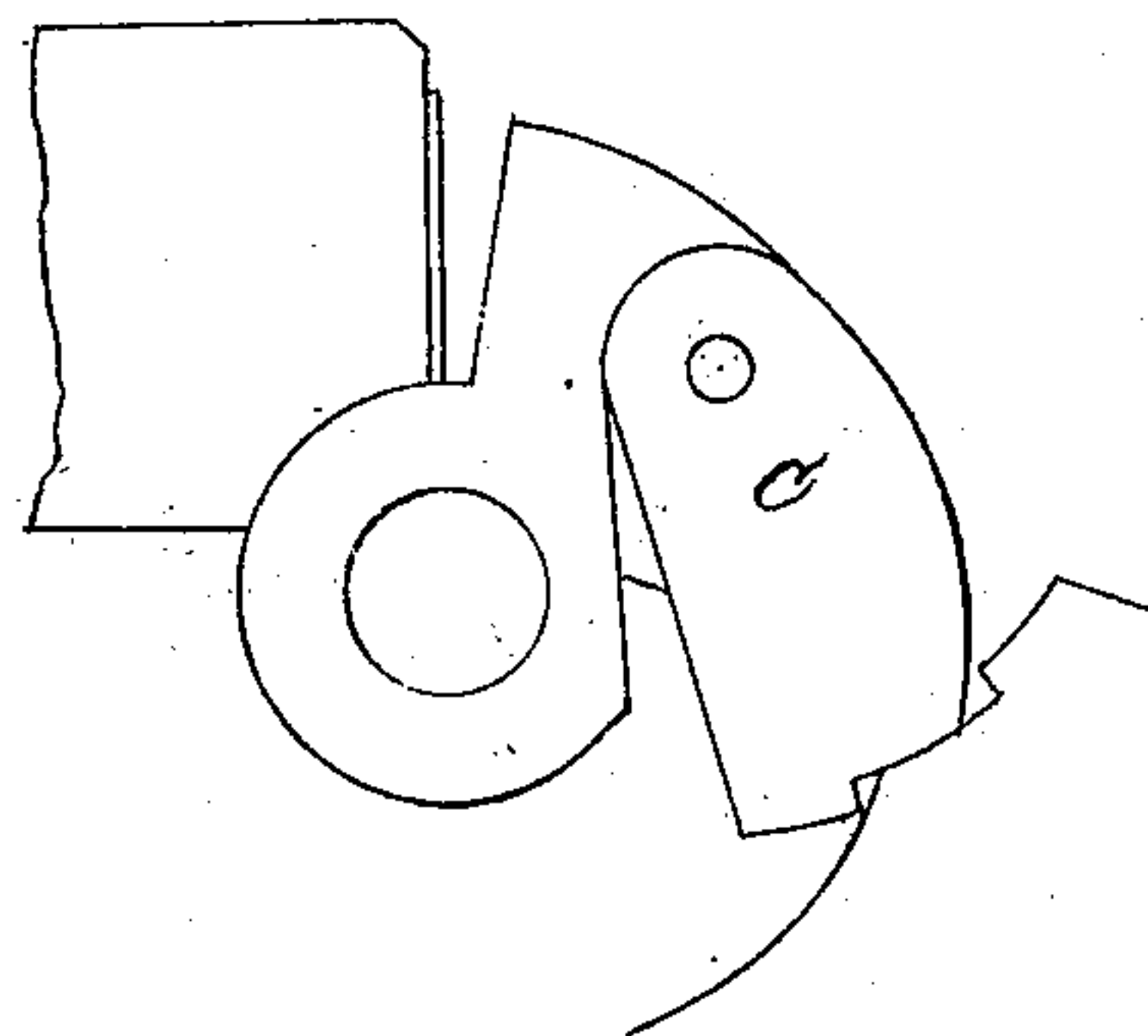

Fig 4.

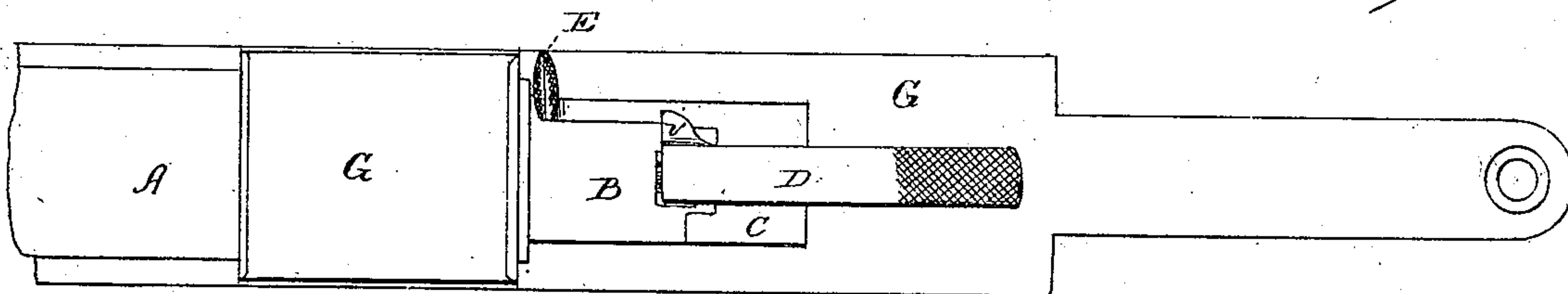
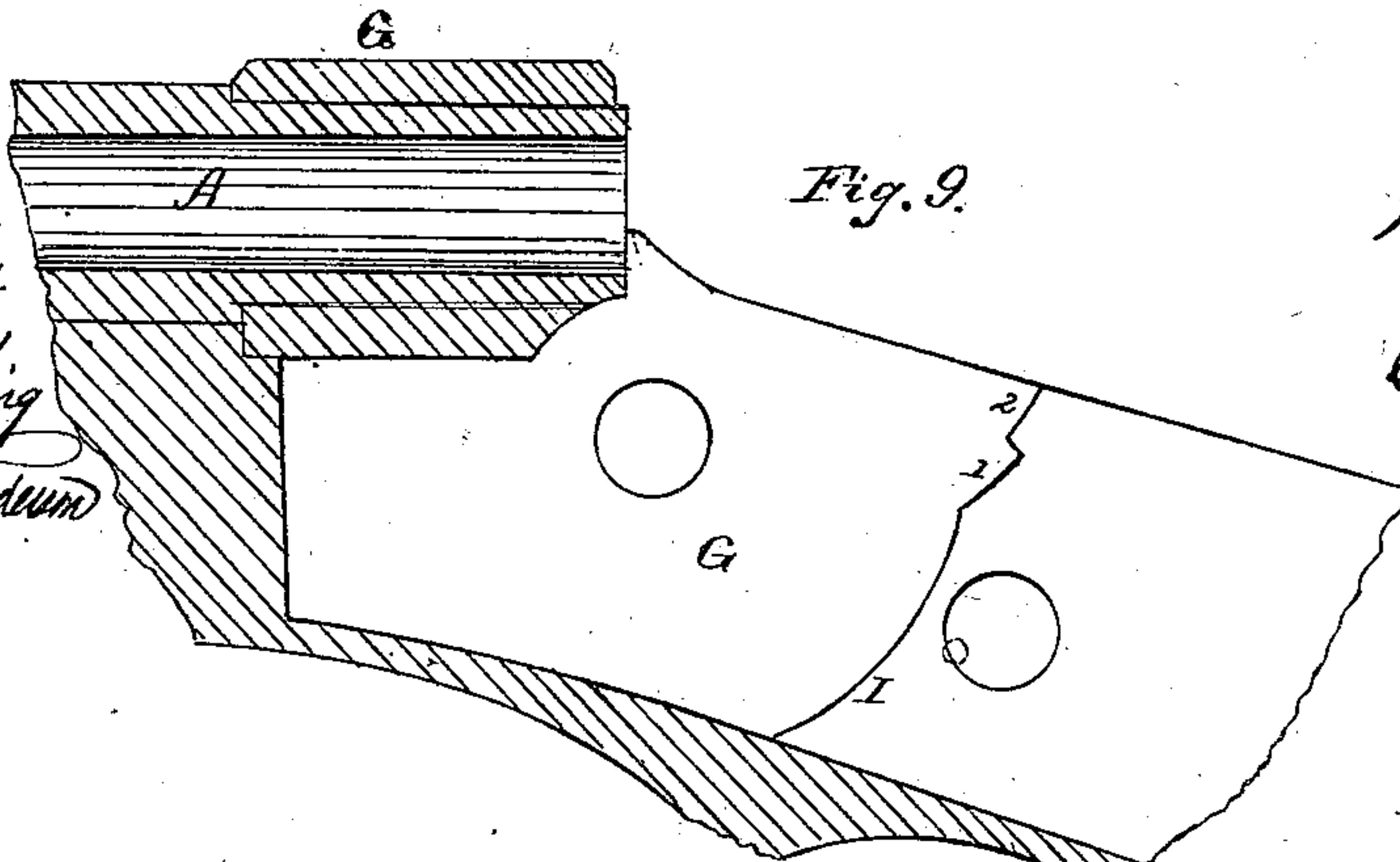

Fig. 9.



Inventors.

Wm. C. Dodge
Philip T. Dodge

Witnesses.

Harry King
A. J. Anderson

UNITED STATES PATENT OFFICE.

WILLIAM C. DODGE AND PHILIP T. DODGE, OF WASHINGTON, DISTRICT OF COLUMBIA; SAID PHILIP T. DODGE ASSIGNS HIS RIGHT TO SAID WILLIAM C. DODGE.

IMPROVEMENT IN BREECH-LOADING FIRE-ARMS.

Specification forming part of Letters Patent No. 112,694, dated March 14, 1871.

To all whom it may concern:

Be it known that we, WILLIAM C. DODGE and PHILIP T. DODGE, of Washington, in the county of Washington and District of Columbia, have invented certain Improvements in Breech-Loading Guns, of which the following is a specification, reference being had to the accompanying drawing.

Our invention relates to breech-loading guns; and the invention consists in a novel method of constructing and arranging the breech mechanism, and the frame in which it operates, whereby the gun is rendered extremely simple, strong, and safe, all as hereinafter more fully described.

Figure 1 is a longitudinal section of the breech or rear portion of the gun, with the breech open. Fig. 2 is a similar view, with the breech closed. Fig. 3 is a top plan view, with all the parts in position as it is when fired. Fig. 4 is a similar view, showing a safety-guard attached to the hammer. Figs. 5, 6, 7, 8, 9, and 10 are portions shown more in detail.

In constructing our improved gun we first provide a frame, G, of the form represented in the drawing, into the front end of which the barrel A is screwed in the usual manner.

On the inner walls or sides of this frame we form a cheek-piece or abutment, I, one on each side, located a short distance in rear of the open end of the barrel, as represented in Figs. 1, 2, and 9.

These cheeks I are formed with their front faces curved, so as to form the arc of a circle, of which the pin *a*, on which the breech-block swings, is the center, this curved face extending from below upward to near the top, where the face of the cheeks is cut away so as to form a recess for the rear portion of the breech-block to rest in, as hereinafter more fully explained, and as shown in Fig. 1, and by dotted lines in Fig. 2, and in Fig. 9.

The frame G being thus constructed, we provide a swinging breech-block, composed of two solid blocks, B and C, the latter being hinged or pivoted to the former in such a manner that its lower or rear end is free to swing to and from the part B, as represented in the drawing, these two parts thus forming a com-

pound breech-block. These two parts should be so hinged to each other as to furnish a bearing upon the solid metal of each, and not bring the strain, in firing, upon the pin that unites them, in case a pin is used, which may or may not be used, as preferred. One manner of uniting these parts is represented in Figs. 1, 2, 3, 4, 5, and 6. In this case the joint is formed by cutting a mortise in the upper end of the part C and a corresponding tenon or tongue on the part B, the upper end of the part C being made on a true circle, and fitted into corresponding sockets or recesses in the back of B, on each side of the tongue, whereby the solid end of the part C, bears directly against the solid metal of part B, on the principle or plan of a knuckle or socket joint.

In order to still further strengthen this joint the bottom or rear face of the tongue on B is formed on a curve concentric with the center of the joint, as shown in Fig. 2, and the corresponding portion of the mortise in the part C is hollowed out, so as to fit snugly against this curved shoulder of the tongue and thus afford a solid bearing at this point also. In this way we produce a joint that affords a solid bearing entirely across the block, the bearing being divided, part being on the upper end of the part C and the rest on the bottom of the tongue below; or, if preferred, the joint may be made as represented in Fig. 8, in which the upper end of part C is simply cut on a circle all the way across, the end being left solid, and then shoved sidewise into a corresponding socket cut in the part B. In this case the bearing is all at one point, instead of at two, as in the other case, but it still extends entirely across the block. If this form of joint be used the part C may be held from moving sidewise by simply cutting a small groove at the center of its upper end, in which the firing-pin shall engage when inserted, the part C being first placed in position and then the firing-pin inserted and secured. It will of course be understood that the object of these methods of constructing the joint in the breech-block is to secure the utmost strength possible.

The axis of the joint may be located either above or below the firing-pin; and if the form

of joint first described be used, the pin n of the joint may also be made to hold the firing-pin in its seat, as shown in Fig. 2. If the second form be used, and it is located above, then it must have an opening in rear of the firing-pin for the hammer to strike through to reach the firing-pin.

Whichever form of joint is used, in all cases the part C is constructed with an arm, which extends from the joint upward to a point just above the part B, where it terminates in a thumb-piece, E, as represented in the several figures, the object of this thumb-piece being to lock and unlock the breech-block and to move the same, as is necessary in manipulating it. This arm we prefer to locate on the right-hand side of the part C, where it fits into a suitably-shaped recess cut in the side of the part B, as shown in Fig. 5, though, by making the block a little wider, the recess may be omitted. It is, however, obvious that the arm may be located centrally, as represented in Figs. 6 and 7, in which case a recess must be cut for it to lie in in the part B, and its upper end should be curved, so as to bring the thumb-piece E out to the right, as represented in Fig. 7.

The lower end of this part C is formed into two steps or shoulders, l and m , as shown clearly in Figs. 1, 2, 5, and 6, each of these shoulders being formed with its outer surfaces concentric with the pin n or axis of the joint, to permit them to swing in and out of the recesses 1 and 2 in the upper portion of the cheeks I, and have a firm and solid bearing therein when the breech is closed, these recesses being in like manner curved and concentric with the axis of the joint of the parts B C when the breech-block is in position as represented in Fig. 2.

It is obvious that the bearing would be the same if the end of part C were made with a single shoulder extending over its entire surface, as in Fig. 8, and the recess in the cheeks made to correspond; but there is a special object in thus constructing these parts, which is to render the arm more secure against accidental and premature explosions.

In this class of guns, which use a swinging breech-block, premature explosions arise from two causes: first, from the concussion of the breech-block against the cartridge, when the breech is closed, and more especially so if the block be heavy and a spring be used to throw and hold the block closed; second, they are still more apt to occur from the firing-pin becoming jammed or stuck fast in its seat with its point protruding from the face of the breech-block, in which case it will of course hit the cap or cartridge as the breech is closed, and thus be likely to ignite the charge. In either case the charge is forced out at the rear end of the barrel, and injury ensues.

Now, by this method of constructing the breech-block in two parts, and having the rear part C lock into the recess in the cheeks

I as the breech is closed, accidents from the first cause are prevented; and, by forming the locking-shoulder and recess in the form of steps, accidents from the second cause are prevented, because, as the breech is closed, the shoulder l first locks on the step 1 of the recess, so that, if the pin at that instant should hit and ignite the charge, the breech-block will be held securely in position; and if, at any time thereafter, the charge should be ignited before the block was entirely closed, still these parts would prevent it from opening beyond this point. It is obvious that the same result might be secured by simply sloping the face of the recess from its upper to its lower point, and forming the end or shoulder of the part C to correspond; but the locking of the parts in position would be less secure, that, however, depending upon the angle at which the part C should be arranged to stand. By this means, also, the rear end of the part C can be swung up flush with the upper edge of the frame G, as represented in Figs. 2 and 3, and thus prevent the formation of any cavity or recess at that point for the reception of dirt, &c., which might interfere with the operation of the parts; and, as the rear end of the part C is thus elevated, it also permits the shoulder r on the hammer to come up flush with the top of the frame G, thus filling the cavity or slot in which the hammer swings, and leaving no cavity for the reception of obstructions.

It will be observed that the hammer is located between the cheeks, in line with and directly in rear of the breech-block. Its lower front face is cut away, or so formed that, when the hammer is at full cock, its lower portion will not swing forward in advance of the cheeks I. This is necessary in order to leave a clear, open space for the breech-block to swing down within the frame, to permit the insertion and removal of the cartridge-shells.

The body of the hammer, above its journal or axis b , is provided with a projecting shoulder, r , which is made concentric with its axes of rotation on its upper face, so that, as the hammer swings forward to ignite the charge, this shoulder r will pass under the lower end of the part C, which is cut away at its center for that purpose, as shown in Fig. 2, and thus lock the part C securely in its recess in the cheeks I.

It will be observed that the front portion of this shoulder is beveled or inclined, as represented at o , Figs. 1 and 2, so that if the part C should happen not to be fully home to its seat in the recess, this incline o on the hammer will force it home to its seat, and the shoulder r be permitted to swing under and lock it there.

As represented in Figs. 2 and 5, a spring, u , is inserted between the lower parts of B and C, which serves to throw the lower end of the latter into the recess in the cheeks, and to

hold it there, previous to the descent of the hammer.

This shoulder *r* also serves another purpose. It will be observed that the parts B and C are so formed and united that, when the part C has its lower end pressed in against the part B to allow the breech to be opened, the rear face of C will then form a continuation, on a true circle, of the outline of B, the two parts thus constituting a segment of a circle, as represented in Fig. 1. Now, if the hammer be released when the part C is thus pressed against the part B, whether the breech be closed or partially open, no matter to what extent, then the front of this shoulder or projection *r* will strike against the rear or segmental surface of the part C and thus prevent the point of the hammer from reaching the firing-pin.

By making the front face of the cheeks I curved, as represented, they serve as a guide for the part C to bear against, when opening and closing the breech; and this is important, because, as in closing the breech the thumb is applied to the rear face of E, the lower end of C is thereby pressed backward, and, if the cheeks were not there to prevent, the end of the part C would be swung back, and would lock under the hammer-bolt *b* and prevent the breech from being closed. In the same manner, also, the spring *u* would throw the part C back and cause it to lock, and interfere with its movement in closing. It is, however, obvious that these cheeks, instead of being formed one on each side, with the hammer between them, as represented, may be made in one single solid abutment, extending entirely across from side to side of the frame, and made to operate in the same manner. In that case the hammer would either have to be located in rear of the abutment or placed on the outside of the frame, which would render the mechanism and its arrangement less compact, and therefore not as good.

In Fig. 4 is shown an additional safety-guard. It consists simply of a projection, *v*, on the side of the hammer, which extends out far enough to strike in rear of the arm of part C, the arrangement of the parts being such that, if the lower end of the part C is not forced home in the recess, this projection *v* will strike against the arm before it reaches the firing-pin. By these means the hammer will force the part C home to its seat before the charge can be ignited; or, failing in this, the hammer will not hit the firing-pin, and,

consequently, the gun will not be discharged.

It is obvious that this safety arrangement may be applied equally well to the arm located at the center of the block as when located at the side.

The operation of the gun is as follows: The hammer being brought to full cock, the breech is unlocked by pressing back on the thumb-piece E, which pressure first moves the end of part C out of its recess in the cheeks and presses it against the part B, when, by continuing the movement, the breech-block is swung down into the cavity in front of the cheeks to the position shown in Fig. 1. A cartridge is then inserted, and the breech closed and locked by simply pressing upward and forward on the thumb-piece E, when the gun is fired in the usual manner.

It will thus be seen that the arm is exceedingly strong, simple of construction, perfectly safe, and can be manipulated with but few motions, and consequently with great rapidity.

Having thus described our invention, what we claim is—

1. A frame for a breech-loading gun, having the cheeks I, with the locking-recess formed therein, substantially as described.

2. The compound breech-block, composed of the parts B and C, the latter being provided with thumb-piece E, and said parts being united by socket-joint, substantially as described, whereby the bearing is thrown upon the solid metal of the parts, substantially as set forth.

3. The hammer D, provided with the shoulder *r*, arranged to operate in relation to the part C of the compound breech-block, substantially as described.

4. The combination of the breech block B C with the cheek-pieces I of the frame, constructed with the locking recess, substantially as described.

5. The shoulder *r*, with the incline *o* at its front, in combination with the locking part C for forcing the latter to its seat in the recess, substantially as set forth.

6. The swinging breech-block, having its locking face or shoulder constructed substantially as described, whereby the breech is locked before it is entirely closed, and the arm thereby rendered more safe, substantially as herein set forth.

WILLIAM C. DODGE.
PHILIP T. DODGE.

Witnesses:

H. B. MUNN,
HARRY KING.